

## SPECIFICATIONS

**CONTACT RATING:** AC 125V 6A, AC 250V 3A, DC 30V 3A

**MECHANICAL LIFE:** 100,000 make-and-break cycles  
DC 10V & 0.1mA.

**CONTACT RESISTANCE:** 10 mΩ max.

**INSULATION RESISTANCE:** 500V 500 MΩ min.

**DIELECTRIC STRENGTH:** 1,000 Vrms min. @sea level.

**OPERATING TEMPERATURE:** -30°C to 85°C.

**WATER-RESISTANCE:** 100 make-and-break cycles min at 10 cm depth for T12 actuator.

## MATERIALS

**CASE:** Diallyl phthalate (DAP) (UL94v-0).

**ACTUATOR:** Brass,chrome plated.

**BUSHING:** Brass,nickel plated.

**HOUSING:** Stainless Steel.

**SWITCH SUPPORT:** Brass,tin plated.

**TERMINAL/CONTACT:** Brass,with silver or gold plated.



## HOW TO ORDER

MODEL NO.	ACTUATOR	BUSHING	TERMINATIONS	TERMINAL PLATING	SEAL	RoHS SOLDERING
<div style="display: flex; justify-content: space-between;"> <div style="width: 15%;"> <p>Model NO.</p> <p><b>1FS1</b> SP On-None-On</p> <p><b>1FS2</b> SP On-None-Mom.</p> <p><b>1FS3</b> SP On- Off -On</p> <p><b>1FS4</b> SP Mom.-Off-Mom.</p> <p><b>1FS5</b> SP On- Off -Mom.</p> <p><b>1FD1</b> DP On-None-On</p> <p><b>1FD2</b> DP On-None-Mom.</p> <p><b>1FD3</b> DP On- Off -On</p> <p><b>1FD4</b> DP Mom.-Off-Mom.</p> <p><b>1FD5</b> DP On- Off -Mom.</p> </div> <div style="width: 15%;"> <p>Actuator</p> <p><b>T1</b> 10.5 high</p> <p><b>T2</b> 5.4 high</p> <p><b>T3</b> 14.2 high</p> <p><b>T4</b> 16.4 high</p> <p><b>T5</b> 21.4 high</p> <p><b>T6</b> 11.5 high</p> <p><b>T61</b> 21.5 high</p> <p><b>T12</b> 11.2 high</p> </div> <div style="width: 15%;"> <p>Bushing</p> <p><b>B6</b> 8.00 high</p> <p><b>BA1</b> 9.00 high</p> <p><b>B9</b> 7.52 high</p> </div> <div style="width: 15%;"> <p>Terminations</p> <p><b>M1</b> Solder Lug</p> <p><b>M2</b> PC thru-hole</p> </div> <div style="width: 15%;"> <p>Terminal plating</p> <p><b>Q</b> Silver</p> <p><b>R</b> Gold</p> <p><b>C</b> Gold over silver</p> </div> <div style="width: 15%;"> <p>Seal</p> <p><b>E</b> EPOXY (std)</p> <p><b>N</b> NO EPOXY</p> </div> <div style="width: 15%;"> <p>RoHS soldering</p> <p><b>S</b> RoHS &amp; Lead Free</p> </div> </div>						

# 1F Series

Miniature Toggle Switches

## SWITCH FUNCTION

NO. POLES	MODEL NO.	SWITCH FUNCTION			CONNECTED TERMINALS / SCHEMATIC		
		POS.1	POS.2	POS.3	POS.1	POS.2	POS.3
SP	1FS1	ON	NONE	ON	2-3	N/A	2-1
	1FS2	ON	NONE	MOM			
	1FS3	ON	OFF	ON			
	1FS4	MOM	OFF	MOM		OPEN	
	1FS5	ON	OFF	MOM			
DP	1FD1	ON	NONE	ON	2-3,5-6	N/A	2-1,5-4
	1FD2	ON	NONE	MOM			
	1FD3	ON	OFF	ON			
	1FD4	MOM	OFF	MOM		OPEN	
	1FD5	ON	OFF	MOM			

MOM=MOMENTARY

## ACTUATOR OPTIONS

T1 STD

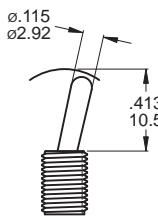

T2

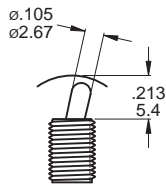

T3

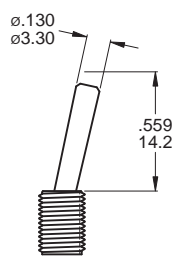

T4

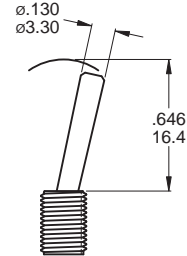

T5

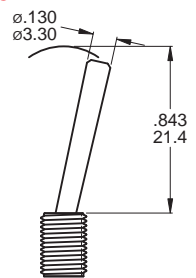

T6 FLATTED WITH ANTIROTATION

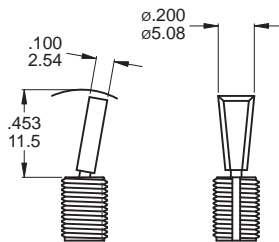

T61

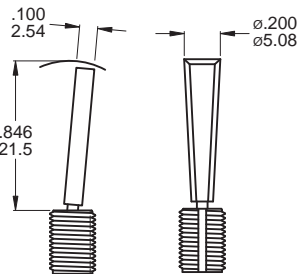

T12

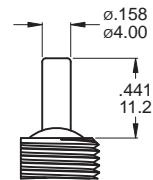

T12 use with BA1 bushing only  
\*T12 actuator mechanical life 200,000 cycles

T6,T6-1 use with B6 bushing only

## TERMINATION OPTIONS

M1 Solder lug

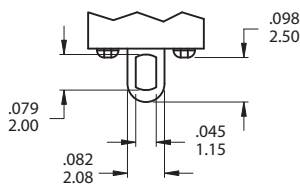

M2 PC Thru - hole

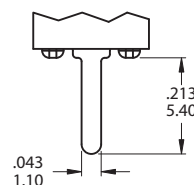

BUSHING OPTIONS

B6 HIGH TORQUE

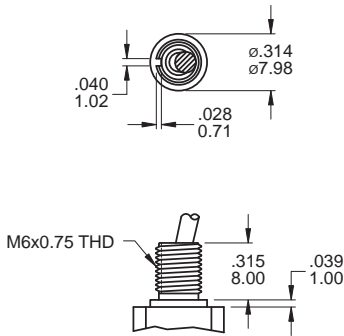

B9 SPLASH PROOF

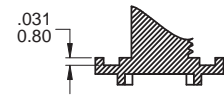
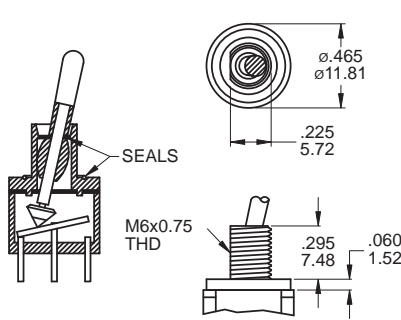

CP-1TEB

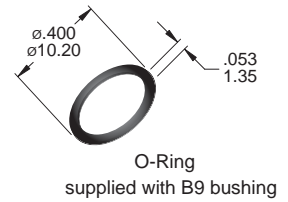

BA1 SPLASH PROOF

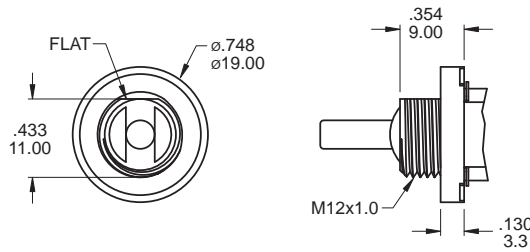

Use with T12 actuators only  
BA1 Bear Strength from top of actuator  
up to 10kg aside up to 15kg

POLE OPTIONS

SPDT

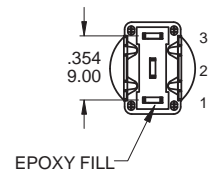
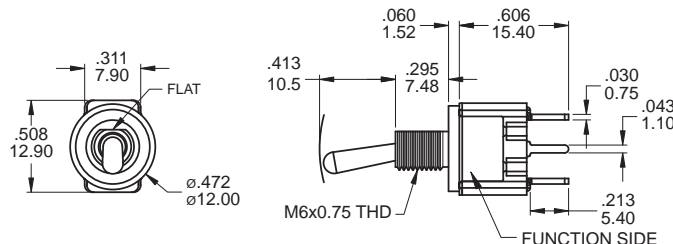

Part No. Shown : 1FS1T1B9M2RES

DPDT

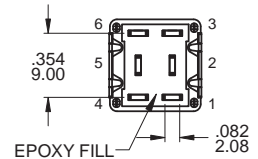
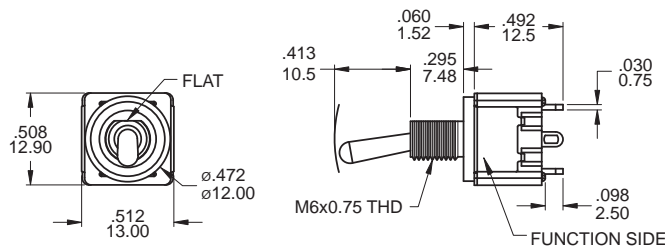

Part No. Shown : 1FD1T1B9M1QES



# 1F Series

Miniature Toggle Switches

1F  
Toggle Switches

## SPDT

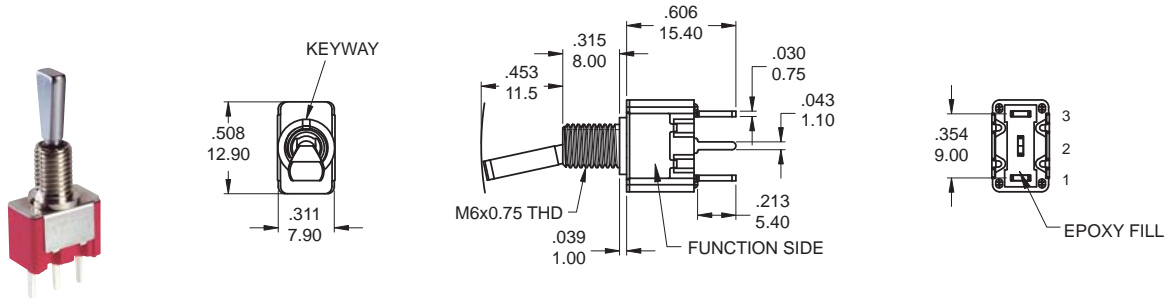

Part No. Shown : 1FS1T6B6M2QES

## DPDT

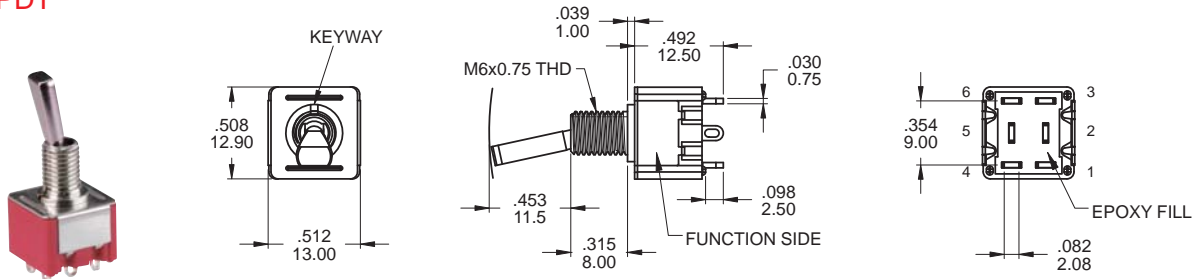

Part No. Shown : 1FD1T6B6M1QES

## SPDT

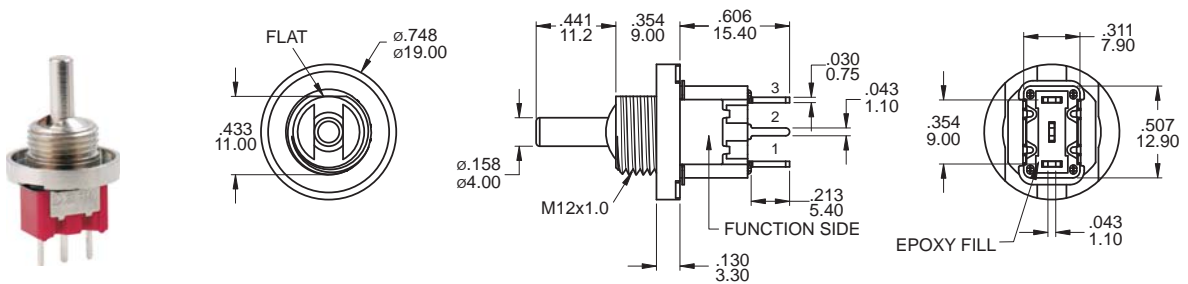

Part No. Shown : 1FS1T12BA1M2QES

## DPDT

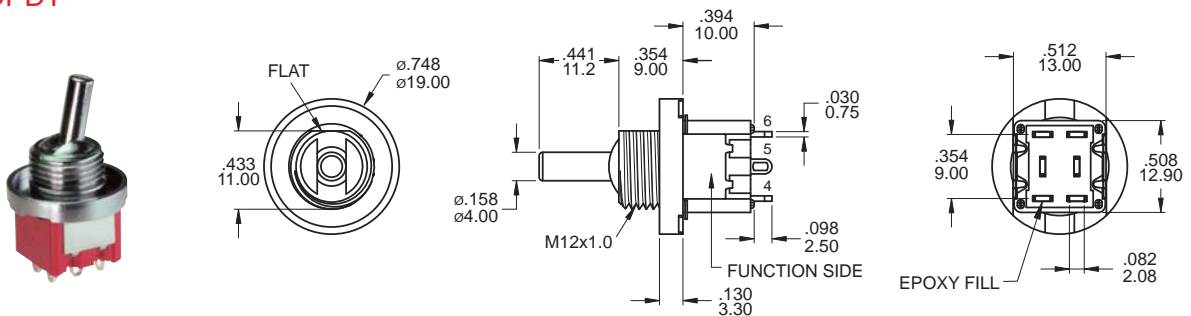

Part No. Shown : 1FD1T12BA1M1QES

**HARDWARE**

**M6x0.75 NUT**

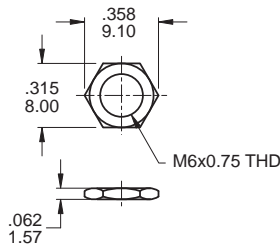

**MNU-1M04**

**LOCKWASHER**

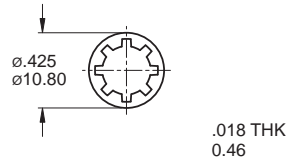

**MNU-1M03**

**LOCKING RING**

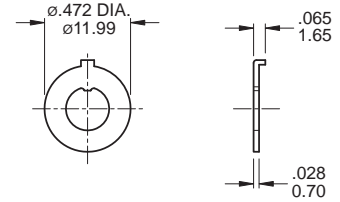

**MNU-1M05**

**M12x1 NUT**

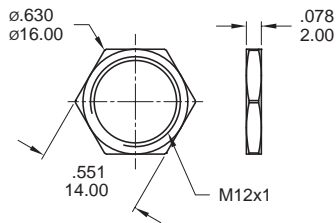

**MNU-1M42**

Supplied standard with BA1 bushing

**LOCKWASHER**

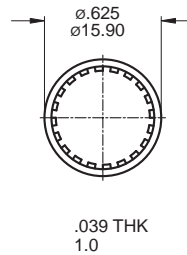

**MNU-1M09**

Supplied standard with BA1 bushing

**O-RING**

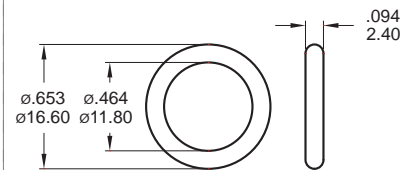

**FCP-1F04**

Supplied standard with BA1 bushing

**CONTACT MATERIAL OPTIONS**

	CONTACT PLATING	TERMINAL PLATING	RATINGS
<b>Q</b>	Silver	<b>Q</b> = Silver	6 Amps with resistant load @ 125VAC 3 Amps with resistant load @ 250VAC or 30VDC
<b>C</b>	Gold over Silver	<b>C</b> = Gold over silver	
<b>R</b>	Gold	<b>R</b> = Gold	0.4 Volt - Amps ( VA ) max. @ 20V max. ( AC or DC )

**SOLDERING PROCESSES**

**MANUAL SOLDERING** : Use soldering iron of 30 watts, controlled at 350°C approximately 5 seconds while applying solder.

**WAVE SOLDERING**: Recommended Soldering Temperature: 270 ± 5°C

Duration of Solder Immersion: Max 5 sec. (PCB is 1.6mm in thickness)



1F  
Toggle Switches