

DMG40960F040_01WTC

DMG40960F040_01WTCZ01

Features:

- Based on T5L0, running DGUS II system.
- 4.0-inch, 400*960 pixels resolution, 262K colors, IPS-TFT-LCD, wide viewing angle.
- LCD and TP frame lamination process.
- Optional TP appearance of black and white.
- COF structure. The entire core circuit of the smart screen is fixed on the FPC of LCM, featured by light and thin structure, low cost and easy production.
- 50 pins, including IO, UART, CAN, AD and PWM from user CPU core for easy secondary development.



DMG40960F040_01WTC



DMG40960F040_01WTCZ01

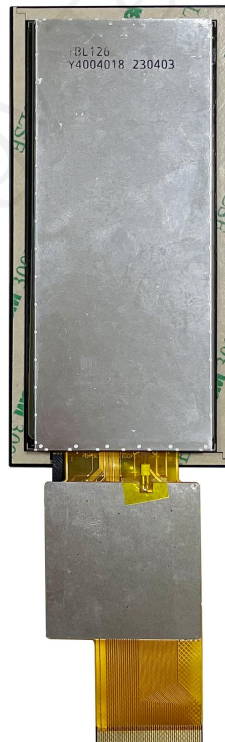

1 External Interface

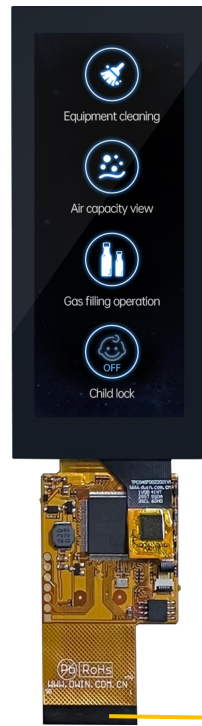

User interface

PIN	Definition	I/O	Functional Description
1	+5V	I	Power supply, DC3.6-5.5V.
2	+5V	I	
3	GND	GND	GND
4	GND	GND	
5	GND	GND	
6	AD7	I	5 input ADCs. 12-bit resolution in case of 3.3V power supply. 0-3.3V input voltage. Except for AD6, the rest data is sent to OS core via UART3 in real time with 16KHz sampling rate. AD1 and AD5 can be used in parallel, and AD3 and AD7 can be used in parallel, which equals to two 32KHz sampling AD. AD1, AD3, AD5, AD7 can be used in parallel, which equals to a 64KHz sampling AD; the data is summed 1024 times and then divided by 64 to obtain a 64Hz 16bit AD value by oversampling.
7	AD6	I	
8	AD5	I	
9	AD3	I	
10	AD1	I	
11	+3.3	O	3.3V output, maximum load of 150mA.
12	SPK	O	External MOSFET to drive buzzer or speaker. The external 10K resistor should be pulled down to the ground to ensure that power-on is low level.
13	SD_CD	IO	SD/SDHC interface, The SD_CD connects a 22pF capacitor to GND near the SD card interface.
14	SD_CK	O	
15	SD_D3	IO	
16	SD_D2	IO	
17	SD_D1	IO	
18	SD_D0	IO	
19	PWM0	O	2 16-bit PWM output. The external 10K resistor should be pulled down to the ground to ensure that power-on is low level. The OS core can be controlled in real time via UART3.
20	PWM1	O	
21	P3.3	IO	If using RX8130 or SD2058 I2C RTC to connect to both IOs, SCL should be connected to P3.2, and SDA connected to P3.3 in parallel with 10K resistor pull-up to 3.3V.
22	P3.2	IO	

23	P3.1/EX1	IO	It can be used as an external interrupt 1 input at the same time, and supports both low voltage level or trailing edge interrupt modes.
24	P3.0/EX0	IO	It can be used as an external interrupt 0 input at the same time, and supports both low voltage level or trailing edge interrupt modes.
25	P2.7	IO	IO interface
26	P2.6	IO	IO interface
27	P2.5	IO	IO interface
28	P2.4	IO	IO interface
29	P2.3	IO	IO interface
30	P2.2	IO	IO interface
31	P2.1	IO	IO interface
32	P2.0	IO	IO interface
33	P1.7	IO	IO interface
34	P1.6	IO	IO interface
35	P1.5	IO	IO interface
36	P1.4	IO	IO interface
37	P1.3	IO	IO interface
38	P1.2	IO	IO interface
39	P1.1	IO	IO interface
40	P1.0	IO	IO interface
41	UART4_TXD	O	UART4
42	UART4_RXD	I	
43	UART5_TXD	O	UART5
44	UART5_RXD	I	
45	P0.0	IO	IO interface
46	P0.1	IO	IO interface
47	CAN_TX	O	CAN interface (External CAN chip drive is required .See 6 - (6) for circuit reference)
48	CAN_RX	I	
49	UART2_TXD	O	UART2(UART0 serial port of OS core)
50	UART2_RXD	I	

2 Specification Parameters

2.1 Product Parameters

Main Chip	T5L0
User Interface	50Pin_0.5mm FPC
FLASH	8M Bytes
UI Version	DGUSII / TA
Power Supply	HDL662S adapter board power supply
Display Color	262K colors
Dimensions	4.0 inch
Resolution	400*960
Active Area	39.18mm (W)×94.03mm (H)
Viewing Angle	Wide viewing angel, typical value of 85°/85°/85°/85°(L/R/U/D)
Backlight Service Life	> 10000 hours (Time of the brightness decaying to 50% on the condition of continuous working with the maximum brightness)
Brightness	250nit
Brightness Control	0~100 grade (When the brightness is adjusted to 1%~30% of the maximum brightness, flickering may occur and is not recommended to use in this range)
TP Type	CTP (Capacitive Touch Panel)
TP Structure	G+G structure
Touch Mode	Single point touch, support continuous sliding touch
Surface Hardness	6H
Light Transmittance	Over 90%
Life	Over 1,000,000 times touch

2.2 Interface Parameters

Item	Conditions	Min	Typ	Max	Unit
Baud Rate	User Set(Configure the CFG file)	3150	115200	3225600	bps
Output Voltage(TXD)	Output 1	3.0	3.3	-	V
	Output 0	-	0	0.3	V
Input Voltage(RXD)	Input 1	-	-	3.3	V
	Input 0	0	-	0.5	V
Interface	UART2: TTL; UART4: TTL; (Only available after OS configuration) UART5: TTL; (Only available after OS configuration)				
Data Format	UART2: N81; UART4: N81/E81/O81/N82;4 modes (OS configuration) UART5: N81/E81/O81/N82;4 modes (OS configuration)				

2.3 Electrical specifications

Rated Power	<2W	
Operating Voltage	3.6~5.5V, typical value of 5V	
Operating Current	200mA	VCC=5V, max backlight
	90mA	VCC=5V, backlight off
Recommended power supply: 5V 0.5A DC		

2.4 Operating Environment

Operating Temperature	-10°C~60°C
Storage Temperature	-20°C~70°C
Operating Humidity	10%~90%RH, typical value of 60% RH

3 Reliability Test

The smart screen products undergo a series of procedural reliability tests, including high and low temperature, ESD, pulse and surge, and waterproof tests before mass production to ensure product quality.

3.1 ESD Test

Test temperature: 25°C

Test process: the product was placed on the test bench to perform contact and air discharge in turn of the serial screen iron frame and display area as shown in Fig.4.1 below. During the experimental process, it was observed whether the screen is dead, black, white, splash, or reboot. According to the experiment results, the performance is in line with the criteria GB/T 17626.2 B level and above.



4.1 Electrostatic discharge test

Discharge Type	Discharge Value	Result
Contact discharge	$\pm 4\text{KV}$	Normal operation
Air discharge	$\pm 4\text{KV}$	Normal operation

3.2 High and Low Temperature Test

Test temperature:-20~70℃

Test process: the product will be placed obliquely in the high and low temperature test chamber for 12h for 20 on and off cycles. Then it will be check at room temperature after power on for the appearance and function, CTP offset situation, jumping point, page random switching and failure.

Temperature	Result
High temperature (70℃)	Normal operation
Low temperature (-20℃)	Normal operation

4 Debug

It is recommended for new users of DWIN smart LCMs to purchase official accessories. For more details, please refer to customer service center.

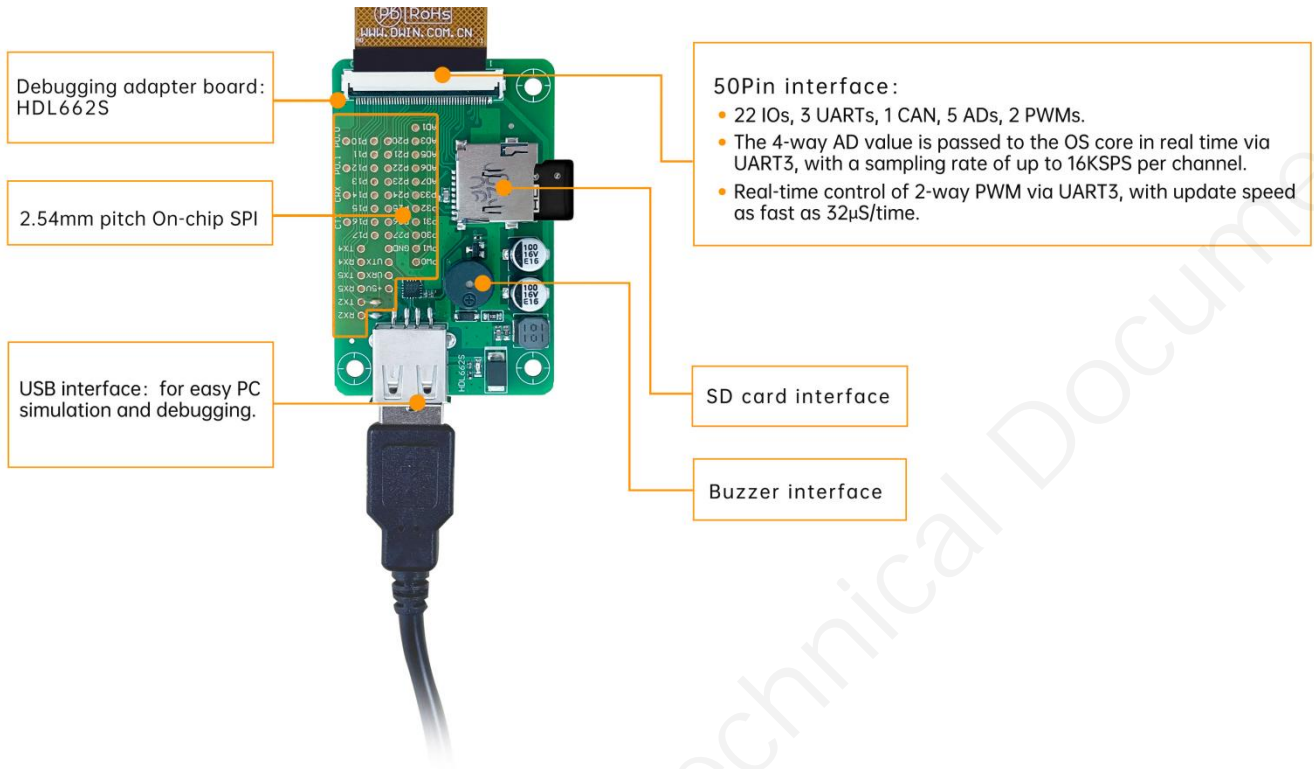

Operation steps: open serial assistant - custom function command - set command - send.

For example:

(1) Page switching

Tx: 5AA5 07 82 0084 5A01 0008

(2) Standby backlight setting

Tx: 5AA5 07 82 0082 64 32 03E8

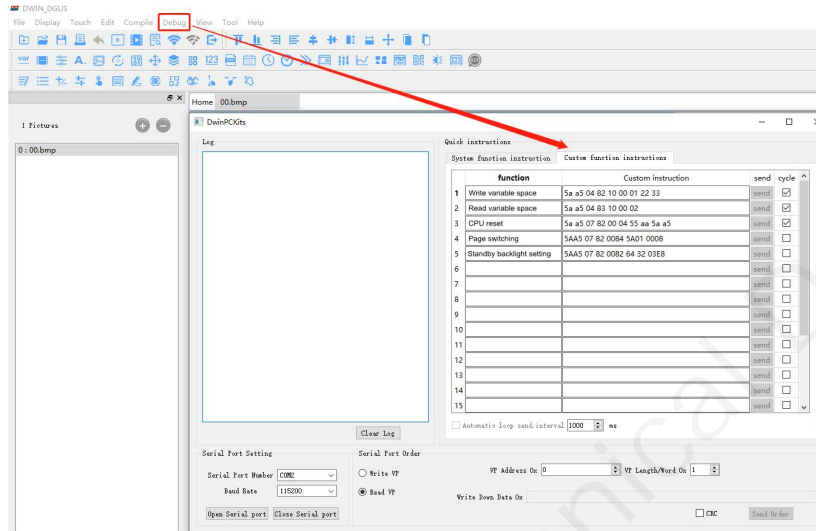

DGUS operation

5 T5L0 ASIC

T5L0 ASIC is a low-power, cost-effective, GUI and application highly integrated single-chip dual-core ASIC designed by DWIN Technology for small-size LCD and mass produced in 2020.

(1) Mature and stable 8051 core which is the most widely used with the maximum operating frequency of T5L is up to 250MHz, 1T(single instruction cycle)high speed operation.

(2) Separate GUI CPU core running DGUS II System:

- High-speed display memory, 2.4GB/S bandwidth. 18-bit color display resolution support up to 1024*768 (TA mode), 854*480 (DGUS mode).
- 2D hardware acceleration and the UI with animation and icons as its main feature is extremely cool and smooth.
- Images and icons stored in JPEG format. Adopt Low-cost 16Mbytes SPI Flash.
- High quality ratio and sound restoration and playback.
- 128Kbytes variable storage space for exchanging data with OS CPU Core and memory.
- 2 10-bit 800KHz DC/DC controllers simplify LED backlight, analog power design and save cost and space.
- Support DGUS development and simulation on PC. Support backend remote upgrade.

(3) Separate CPU (OS CPU) core runs user 8051 code or DWIN OS system and user CPU is omitted in practical application:

- Standard 8051 core and instruction set, 64Kbytes code space, 32Kbytes on-chip RAM.
- 64-bit integer mathematical operation unit (MDU), including 64-bit MAC and 64-bit divider.
- Built-in software WDT, 3 16-bit Timers, 12 interrupt signals support up to four levels of interrupt nesting.
- Support IAP online simulation and debugging with unlimited breakpoints.
- Upgrade code online through DGUS system.

(4) 1Mbytes on-chip Flash with DWIN patent encryption technology ensure code and data security.

(5) Operating temperature ranges from -40°C to +85°C(IC operating temperature customizable from -55°C to 105°C).

(6) Low power consumption and strong anti-interference ability. It can work stably on double-sided PCB and passes EMC/EMI test easily.

6 COF Screen Secondary Development

Standard 8051 core, easy to develop in C language and assembly language.

(1) 22 IOs:

To use output function of IO, you need to open the output control, output strength and peripheral multiplexing power-on initialization configuration. Subsequent use of IO is consistent with the standard 8051 as follows.

```
#include "sys.h"
sbit LED1 = P1^0;
sbit KEY1 = P1^1;
//Pin initialization
void io_init()
{
    PORTDRV = 0x01;//Driving current is 8mA
    P1MDOUT |= 0x01;//Set P1.0 as output to drive LED1 light
    P1MDOUT &= 0xFD;//Set P1.1 as input to read the voltage level change of the pin
}
void main(void)
{
    u16 cnt_1ms;
    u16 key1_sta;//Store the voltage level state of the KEY1 pin
    sys_init();//System initialization
    io_init();//Pin initialization
    cnt_1ms = 0;
    key1_sta = KEY1;
    while(1)
    {
        cnt_1ms++;
        sys_delay_ms(1);// Delay sub-function, LED1 blinks every 500ms.
        if(cnt_1ms==500)
        {
            LED1 = !LED1;
            cnt_1ms = 0;
        }
        //If the voltage level of the pin has changed, it will be updated in the interface
        if(key1_sta!=KEY1)
        {
            key1_sta = KEY1;
            sys_write_vp(0x1000,(u8*)&key1_sta,1);
        }
    }
}
```

(2) 3 UARTs:

High-speed serial port, supporting up to 3225600bps,as follows.

```
#include "sys.h"
#include "uart2.h"
void main(void)
{
    u16 len;
    sys_init();//System initialization
    uart2_init(115200);//Initialize serial port 2
    while(1)
    {
        if(uart2_rx_sta&UART2_PACKET_OK)//Received serial packet
        {
            len = uart2_rx_sta&UART2_PACKET_LEN;//Get the length of the serial packet without "\r\n"or '\n' terminator
            uart2_buf[len++] = 0;//Add 2 empty strings at the end
            uart2_buf[len++] = 0;
            printf("T5L_C51:%s\r\n",uart2_buf);//Return the received packet to the sender with the prefix "T5L_C51:"
            sys_write_vp(0x2000,uart2_buf,len/2+1);//At the same time display the packet to the interface
            uart2_rx_sta = 0;//Reset means that this serial packet is disposed of
        }
    }
}
```

(3) 1 CAN:

Only the special function registers of the CAN need to be configured as follows.

```

void CanInit()
{
    P0MDOUT = 0x04;    //P0.2(CAN_TX) is configured as output
    P0 = 0xFF;        //Output high voltage level
    ADR_H = 0xFF;     //Configuring DGUS variable memory addresses
    ADR_M = 0x00;
    ADR_L = 0x60;
    ADR_INC = 1;     //Configure address increments
    RAMMODE = 0x8F;  //Write mode
    while(!APP_ACK); //Waiting for confirmation,Among answers of Hardware to 8051 occupied variable memory request,
    1=OK and 0=BUSY, which need to continue to wait.
    DATA3 = 0x1A;   //Variable memory address 0xFF:0060 assignment
    DATA2 = 0x17;
    DATA1 = 0x0F;
    DATA0 = 0;
    APP_EN = 1;
    while(APP_EN);  //Wait for the data operation to be completed, and reset after the operation is completed
    DATA3 = 0;     //Acceptance register 0xFF:0061 assignment reset
    DATA2 = 0;
    DATA1 = 0;
    DATA0 = 0;
    APP_EN = 1;
    while(APP_EN); //Wait for the data operation to be completed, and reset after the operation is completed
    DATA3 = 0xFF; //Acceptance Mask Register 0xFF:0062 all set to 1, and no acceptance of reception
    DATA2 = 0xFF;
    DATA1 = 0xFF;
    DATA0 = 0xFF;
    APP_EN = 1;
    while(APP_EN); //Wait for the data operation to be completed, and reset after the operation is completed
    RAMMODE = 0;   //Terminate access to DGUS variable memory
    CAN_CR = 0xA0; //Open CAN and configure FF0060-FF0062
    while(CAN_CR&0x20); // Execute the configuration of FF0060-FF0062
    ECAN = 1;     //Open the CAN interrupt
    EA = 1;      //Open the total interrupt
}
    
```

(4) 5 A/Ds: 12-bit, supports sampling to 16-bit

Only the special function registers of the A/Ds need to be configured as follows.

```

#include "sys.h"
#include "adc.h"
void main(void)
{
    u16 ad;
    float vol;
    sys_init();//System initialization
    while(1)
    {
        ad = adc_read_avg(ADC_CHANNEL0,10);//1.Read the ad value of channel 0
        vol = ad*(3300.0f/4095);//2.Calculate the voltage in mV
        sys_write_vp(0x2000,(u8*)&ad,1);// Update the ad value
        sys_write_vp(0x2001,(u8*)&vol,2);//Update the voltage value
    }
}
    
```

(5) 2 PWMs: 16-bit high accuracy, adjustable resolution.

Only need to configure the frequency and duty cycle of PWM as follows.

```
void Pwm_0()
{
    u8 i=0;
    u8 temp[6]={0xAA,0x20,0x42,0x56,0x78,0}; //Set the pwm_0 duty cycle to 100%
    Write_Dgus(0x87,0x2042); //Configure the frequency 100khz
    Write_Dgus(0x86,0x5A01); //
    for(i=0;i<5;i++) //Checksum
        temp[5]+=temp[i];
    for(i=0;i<6;i++) //Configure the duty cycle
        OneSendData3(temp[i]);
}
```

(6) CAN circuit design parameters

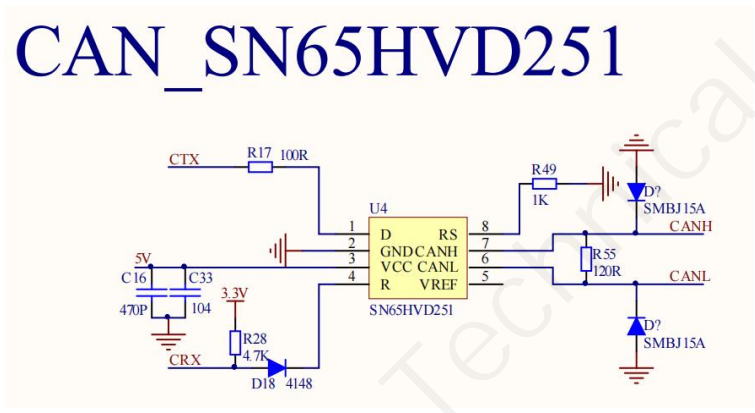

7 Packing Capacity & Dimension

Dimension				
Dimension	52.70(W) × 110.25(H) × 4.10(T) mm			
Net Weight	45g			
Packing Capacity				
Model	Size	Layer	Quantity/Layer	Quantity(Pcs)
Carton1:	220mm(L)×160mm(W)×47mm(H)	1	4	4
Carton2:	250mm(L)×200mm(W)×80mm(H)	1	8	8
Carton3:	320mm(L)×270mm(W)×80mm(H)	1	16	16
Carton4:	450mm(L)×350mm(W)×300mm(H)	2	60	120
Carton5:	600mm(L)×450mm(W)×300mm(H)	3	80	240

Disclaimer: The product design is subject to alternation and improvement without prior notice.

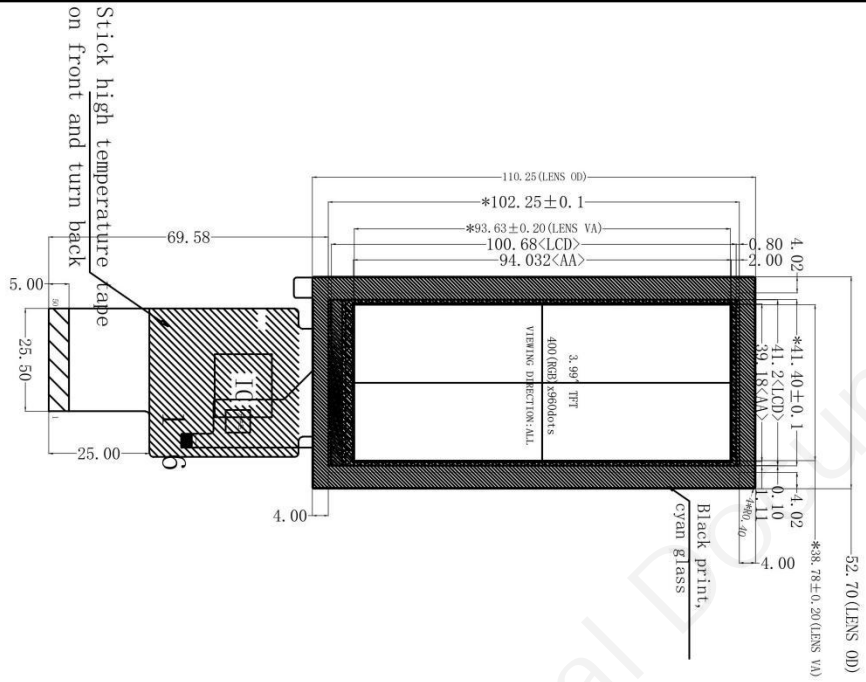

Front view

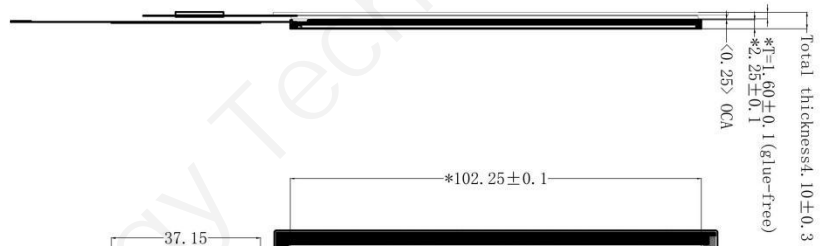

Side view

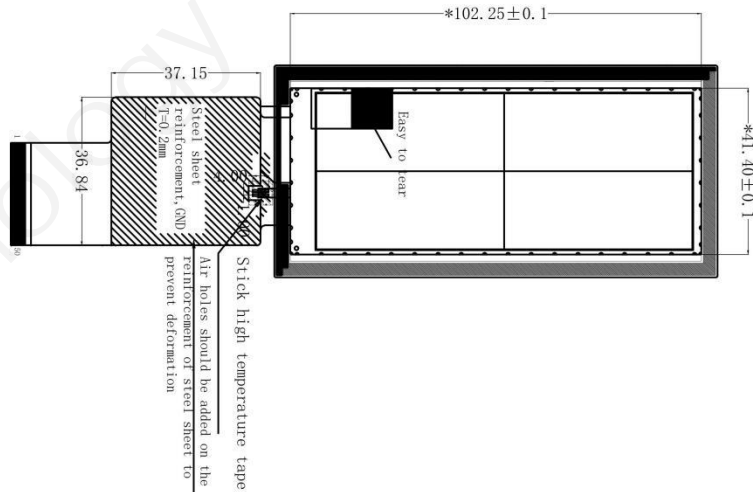

Back view

LED CIRCUIT DIAGRAM:



- NOTES:
1. Display: 3.99" TFT IPS, NORMALLY BLACK;
 2. Driver IC: ST7701S
 3. STORAGE TEMPERATURE: -30° C TO 80° C;
 4. BE. LED: 7 CHIP-WHITE LED, VF=21V, IF=20mA; LCM Brightness: -cd/m2 (MIN) :
 5. * CRITICAL DIMENSION: () REFERENCE DIMENSION;
 6. GENERAL TOLERANCE: ±0.2;
 7. Meet the level 1 environmental prohibited management substances

Both SDA and SCL need to pull up 4.7k resistance

PIN definition

PIN#	Name
1	VDD-3.3V
2	RST
3	SCL
4	INT
5	SDA
6	GND

LCD Pin Definition

PIN#	Name	26	27	28	29	30	31	32	33	34	35	36	37	38	39	40	41	42	43	44	45	46	47	48	49	50
1	+5V	P26	P25	P24	P23	P22	P21	P20	P17	P16	P15	P14	P13	P12	P11	P10	TX4	TX4	TX5	RX5	P00	P01	P02	P03	TX2	RX2
2	+5V																									
3	GND																									
4	GND																									
5	GND																									
6	ADC7																									
7	ADC6																									
8	ADC5																									
9	ADC3																									
10	ADC1																									
11	+3.3V																									
12	SPK																									
13	SD CD																									
14	SD CK																									
15	SDD3																									
16	SDD2																									
17	SDD1																									
18	SDD0																									
19	PWM0																									
20	PWM1																									
21	P33																									
22	P32																									
23	P31																									
24	P30																									
25	P27																									

DWIN Technology

REVISION RECORD	VER	DATE	FILE NAME	DESCRIPTION	DESIGN	DATE	SCALE	TOLERANCES
First Edition	VI-1		DMG40960F040_01WTC				1:1	±0.2

DATE	APPROVED BY	DATE	DATE	DATE	DATE	DATE	DATE	DATE

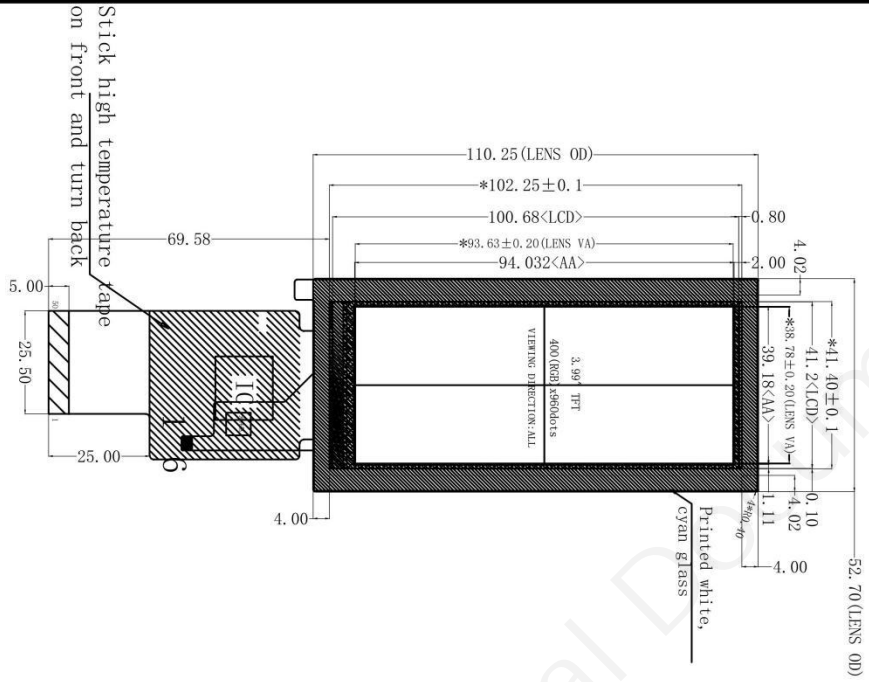

Front view

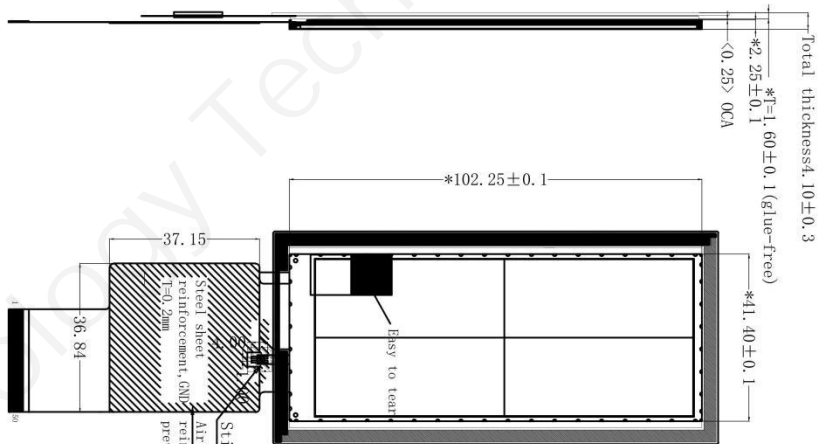

Side view

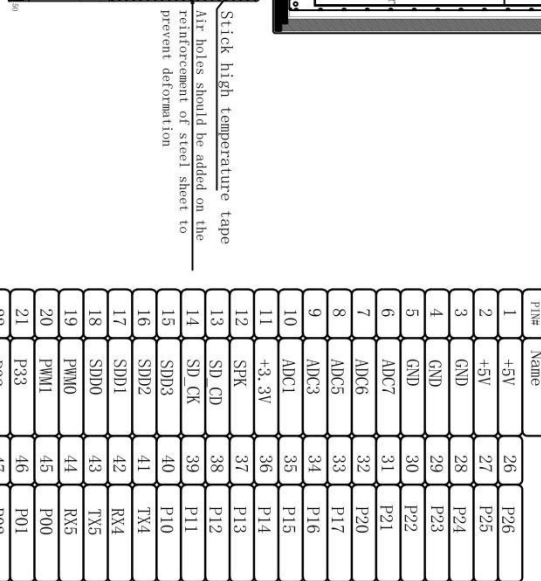

Back view

LCD Pin Definition

Pin#	Name	26	27	28	29	30	31	32	33	34	35	36	37	38	39	40	41	42	43	44	45	46	47	48	49	50
1	+5V	P26	P25	P24	P23	P22	P21	P20	P17	P16	P15	P14	P13	P12	P11	P10	TX4	RX4	TX5	RX5	P00	P01	P02	P03	TX2	RX2
2	+5V																									
3	GND																									
4	GND																									
5	GND																									
6	ADC7																									
7	ADC6																									
8	ADC5																									
9	ADC3																									
10	ADC1																									
11	+3.3V																									
12	SPK																									
13	SD CD																									
14	SD CK																									
15	SD D3																									
16	SD D2																									
17	SD D1																									
18	SD D0																									
19	PWM0																									
20	PWM1																									
21	P33																									
22	P32																									
23	P31																									
24	P30																									
25	P27																									



LED CIRCUIT DIAGRAM:

- NOTES:
1. Display: 3.99" TFT IPS, NORMALLY BLACK;
 2. Driver IC: ST7010;
 3. STORAGE TEMPERATURE: -30° C TO 80° C;
 4. OPERATING TEMPERATURE: -20° C TO 70° C;
 5. CHROMATICITY COORDINATE: X: 0.31 ± 0.03, Y: 0.31 ± 0.03;
 6. GENERAL TOLERANCE: ± 0.2;
 7. Meet the level 1 environmental prohibited management substances

Pin#	Name
1	VDD-3.3V
2	RST
3	SCL
4	INT
5	SDA
6	GND

Both SDA and SCL need to pull up 4.7k resistance
PIN Definition

REVISION RECORD			DWIN Technology		
First Edition	VER	DATE	FILE NAME	DESIGNER	DATE
	V-1		DMG40960F040_01WTCZ01		
			CUSTOMER NAME :	ISSUER:	ANALYS : ± 0.1°
			DESIGN :	RELEASE: V-1	SCALE: 1:1
			DRAWN BY: D.ZQ	DATE: 2023/04/25	UNIT: mm
			CHECKED BY:	DATE:	PRO. (3x)
			APPROVED BY:	DATE:	SHEET: 1/1

8 Revision records

Rev	Revise Date	Content	Editor
00	2023-05-16	First Edition	Xu Ying

Please contact us if you have any questions about the use of this document or our products, or if you would like to know the latest information about our products:

- Customer service Tel: +86 400 018 9008
- Customer service email: dwinhmi@dwin.com.cn
- DWIN Developer Forum: <https://forums.dwin-global.com/>

Thank you all for continuous support of DWIN, and your approval is the driving force of our progress!