

Data Sheet AM2305B

Humidity and Temperature Module

- Relative humidity and temperature output
- Superior sensor performance, typical accuracy RH: $\pm 2\%$, T: $\pm 0.3^{\circ}\text{C}$
- Wide voltage support 3.3 to 5.5V DC
- Excellent long-term stability
- Fast-response and anti-interference capability

Product Summary

AM2305B consists of an all-new-design ASIC dedicated chip, an improved MEMS capacitive humidity sensor and a standard on-chip temperature sensor. The performance and reliability have been greatly improved, surpassing the level of the previous generations. The new generation sensor module has a more stable performance in harsh environment. At the same time, AM2305B has higher cost-effectiveness and applicability, due to the improvement from miniaturization. Each sensor is strictly calibrated and tested to ensure its high quality.

1 Product Description

The AM2305B is a kind of sensor of humidity and temperature with One-Wire Bus Protocol. It can be applied to HVAC, dehumidifier, testing and inspection equipment, consumer products, automobiles, automatic control, data loggers, weather stations, home appliances, humidity control, medical and other application fields which need to detect and control temperature and humidity.



Figure 1. AM2305B

2 Sensor Specifications

Relative Humidity

Parameter	Condition	Min	Typical Value	Max	Unit
Resolution	Typical	-	0.1	-	%RH
Accuracy Tolerance ¹	Typical	-	±2	-	%RH
	Max	See Figure 2		-	%RH
Repeatable	-	-	±0.1	-	%RH
Hysteresis	-	-	±1	-	%RH
Nonlinear	-	-	<0.1	-	%RH
Response Time ²	τ 63%	-	8	-	s
Scope of Work	Extended ³	0	-	100	%RH
Prolonged Drift ⁴	Normal	-	<1	-	%RH/yr

Table 1. Humidity characteristics table

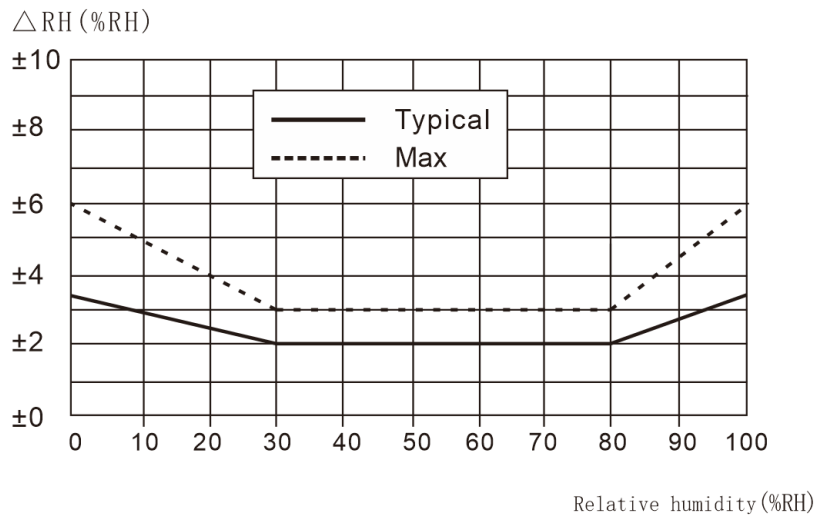

Figure 2. Typical and maximum humidity errors

Electrical Specifications

Parameter	Condition	Min	Typical Value	Max	Unit
Supply Voltage	Typical	3.3	5	5.5	V
Supply Current, I_{DD} ⁵	Sleep	-	0	-	μA
	Measure	-	1.5	-	mA
Power Consumption ⁶	Dormancy	-	-	0.8	μW
	Measure	-	7.5	-	mW
Communication	One-Wire Bus Protocol				

Table 2. Electrical Specifications

Temperature

Parameter	Condition	Min	Typical Value	Max	Unit
Resolution	Typical	-	0.1	-	°C
Accuracy	Typical	-	±0.3	-	°C
Tolerance ¹	Max	See Figure 3		-	°C
Repeatable	-	-	±0.1	-	°C
Hysteresis	-	-	±0.1	-	°C
Response Time ²	τ 63%	5	-	30	°C
Scope of Work	Extended ³	-40	-	80	°C
Prolonged Drift ⁴	Normal	-	<0.1	-	°C/yr

Table 3. Temperature characteristics table

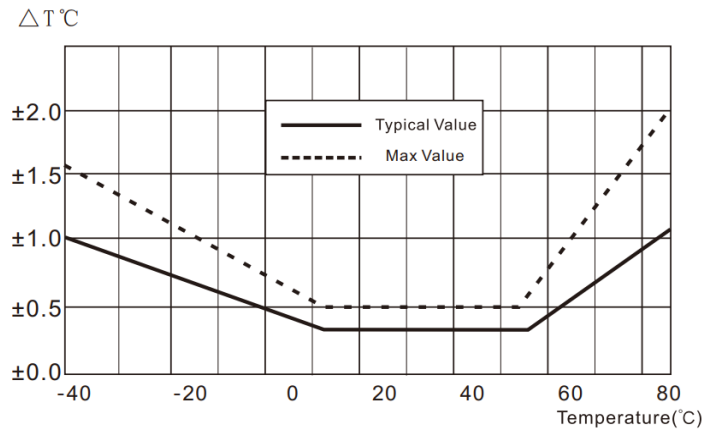

Figure 3. Typical and maximum temperature errors

1. This accuracy is based on the sensor's test accuracy at a supply voltage of 3.3V at 25°C during the factory inspection. This value does not include hysteresis and non-linearity and applies only to non-condensing conditions.
 2. The time required to reach the first-order response of 63% at 25°C and 1 m/s airflow.
 3. Normal operating humidity range: 0-80%RH. There will be deviation in the sensor reading (after 60 hours in 90%RH humidity, drift >3%RH) beyond this range. The working condition is limited to -40°C -80°C.

4. Output signal may be high if the sensor is surrounded by volatile solvents, offensive odor tapes, adhesives, and packaging materials. Please refer to the relevant documentation for detailed instructions.
 5. The minimum and maximum values for supply current and power consumption are based on VCC = 3.3V and T < 60°C.
 6. The response time depends on the thermal conductivity of the substrate of the sensor.

3 Expansion Performance

3.1 Operating Conditions

The performance of the sensor is stable within the recommended working condition shown in figure 4. Long-term exposure to the condition that outside of the normal range of conditions, especially humidity is over 80%, may cause the output signal temporary drift (drift + 3% RH after 60 hours). After returning to the normal working condition, the sensor will slowly recover to the calibration status. Refer to "Recovery Processing" in section 4.3 to accelerate the recovery process. Long-term operating under the abnormal conditions will accelerate the aging of the sensor.

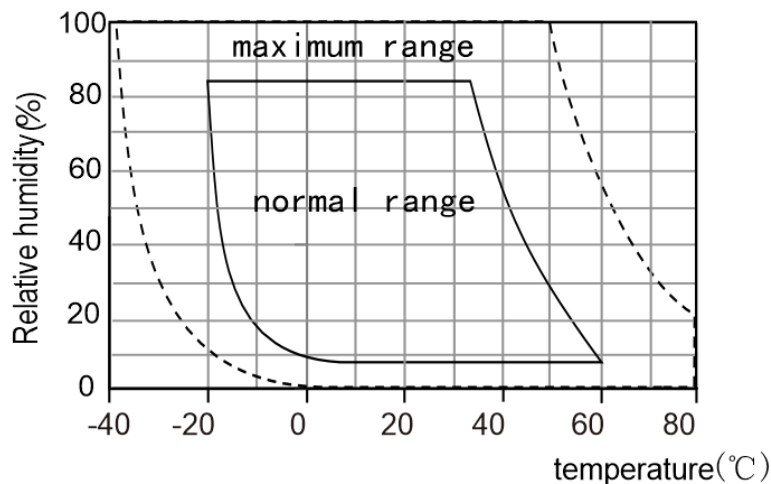

Figure 4. Working conditions

3.2 RH Accuracy at Different Temperatures

Figure 2 defines the RH accuracy at 25°C, and Figure 5 shows the typical humidity error for other temperature ranges.

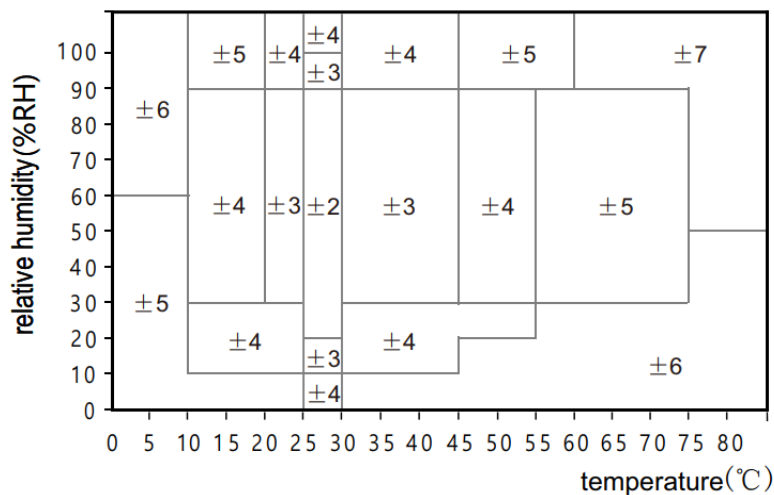

Figure 5. The typical error of humidity in the range of 0~80°C, unit: (%RH)

Please note: The above error is the typical error (excluding hysteresis) of the reference instrument test with a high-precision dew point meter.

4 Applications

4.1 Welding Instructions

It is forbidden to use reflow soldering or wave soldering for soldering. The manual soldering must be contacted for less than 5 seconds at the highest temperature of 300°C.

Note: After welding, AM2305B need to be stored in the condition >75%RH for over 12 hours to ensure the rehydration of the polymer. Otherwise, the output signal of the sensor will drift. The sensor can also be placed in a natural environment (>40%RH) for more than 2 days to rehydrate it. The use of low temperature solder (for example: 180°C) can reduce the hydration time.

If the sensor is operating in the condition of corrosive gas or condensed water (such as: high humidity environment), the pin pad and PCB need to be sealed (such as: use conformal coating) to avoid poor contact or short circuit.

4.2 Storage Conditions and Operating Instructions

The level of the humidity sensitivity (MSL) is 1, according to the IPC/JEDEC J-STD-020 standard. Therefore, it is recommended to use it within one year after shipment.

This kind of the sensor is not an ordinary electronic component and needs to be carefully protected. Users must pay more attention to this key point. Long-term exposure to high concentrations of chemical vapor will cause the output signal of the sensor drift. Therefore, it is recommended to store the sensor in the original packaging including a sealed ESD bag, and meet the following conditions: temperature range 10°C - 50°C (a limited time within 0-85°C); humidity 20-60%RH (the sensor without ESD package). For those sensors which had been removed from the original packaging, we recommend to store them in an antistatic bag made of PET/AL/CPE containing metal.

During production and transportation, the sensor should be avoided to contact with high concentrations of chemical solvents and long-term exposure in the air. It is should to avoid to contact with volatile glues, tapes, stickers or volatile packaging materials, such as foam foils and foam materials, etc. The area of production should be well ventilated.

4.3 Recovery Processing

As mentioned above, if the sensor had been exposed to extreme working conditions or chemical vapors, the output signal will drift. It can be restored to the calibration state by the following processing.

Drying: Keep for 6 hours under 60-65°C and <5%RH humidity conditions;

Rehydration: Keep for 6 hours under 20-30°C and >75%RH humidity conditions⁷.

4.4 Temperature Effect

The relative humidity of the gas depends to a large extent on the temperature. Therefore, it is necessary to ensure that all sensors measuring the same humidity operate at the same condition of temperature. It should to make sure that the tested sensor and the reference sensor are at the same conditions when operate the test, and then compare the output signals.

In addition, when the measurement is at high frequency, the temperature of the sensor will rise, so it will affect the accuracy. If you want to ensure the variation of the temperature of the sensor is less than 0.1°C, the activation time of AM2305B should not exceed 10% of the measurement time. It is recommended to measure the data every 2 seconds.

4.5 Materials for Sealing and Encapsulation

Many materials can absorb moisture and will act as a buffer, which will increase the time of response and lag. Therefore, the materials around the sensors should be carefully selected. The recommended materials are: metal materials, LCP, POM(Delrin), PTFE(Teflon), PE, PEEK, PP, PB, PPS, PSU, PVDF, PVF.

Material used for sealing and bonding (conservative recommendation): It is recommended to use epoxy resin or

⁷75%RH can be easily generated from saturated NaCl.

silicone resin to encapsulate electronic components. The gases released by these materials may also contaminate AM2305B (see 4.2). Therefore, the sensor should be assembled last, and stored in a well-ventilated place, or dried for 24 hours in an environment of >50°C , so as to release the polluted gas before packaging.

5 Pin Definitions

5.1 Pin Assignment

Pin-No	Name	Description
1(Red)	VDD	Power Supply (3.3V-5.5V)
2(Yellow)	SDA	Serial data, two-way port
3(Black)	GND	Ground supply
4	NC	No Connection

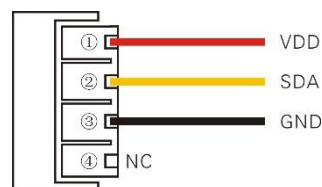

Figure 6. AM2305B Wiring Diagram

5.2 Power Pin (VDD)

Supply voltage is from 3.3V to 5.5V.

5.3 Serial Data Pin (SDA)

The SDA pin is a three state structure that is used to read and write sensor data. Further information about timing and communication between the sensor and micro controller is explained in the detailed description of the communication protocol.

6 Single Bus Communication Protocol

AM2305B serial interface has been optimized to read signal and reduce power loss. The sensor is output by single bus communication, and the single bus is fully compatible with the single bus communication of other products of our company. When reading the AM2305B sensor, please follow the protocol of communication in a timely manner. Specific communication protocol is shows as follow.

6.1 One-Wire Bus Protocol

6.1.1 Block Diagram

The block diagram of figure 7 shows the typical application circuitry of the AM2305B with micro-controller. In one-wire communication mode, the SDA is connected to the I/O port of the microprocessor after it is pulled up.

Note:

- 1.Cable length shorter than 30 meters with 4.7K pull-up resistor proposed in the typical application circuit, more than 30 meters according to the actual situation of lower pull resistance.
- 2.When using 3.3V voltage supply, the length of connection wire shall not be greater than 1m. Otherwise, the line pressure drop will cause insufficient sensor power supply, resulting in measurement errors.
- 3.Read the sensor minimum every 2 seconds, If the reading interval is less than 2 seconds, may lead to temperature or humidity is not allowed or communication is not successful.
- 4.In fact, the readings are last measured value each time. In order to get real-time data, continuously read two times, or read sensors continuously several times and the reading interval is greater than 2 seconds .

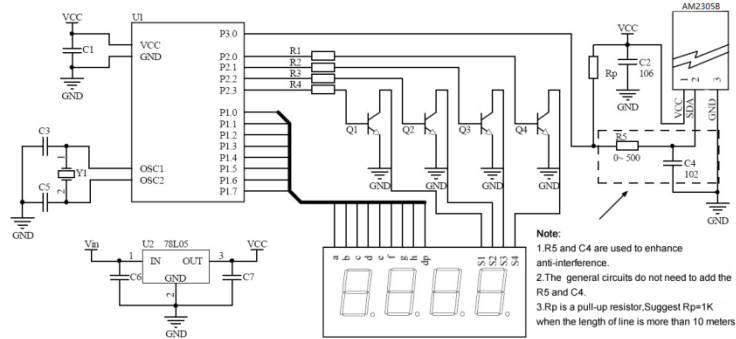

Figure 7. AM2305B One-Wire Application Circuitry

6.2 One-Wire Communication Agreement

6.2.1 Descriptions

The AM2305B uses simplified single bus communication, the 1-wire bus has only one data line, and the data exchange and control in the system are completed by the data line. The micro-controller is connected to the data line via a drain open circuit or a three state port, allows the device to release the bus without sending data, let other devices use the bus. A single bus usually requires an external pull up resistor of about 4.7k, thus, when the bus is idle, the state is high. Because they are the principal and subordinate structure, only the host call sensor, the sensor can response, so the host access sensor must strictly follow the single bus sequence, if the sequence of chaos, sensor will not respond to host.

6.2.2 One-Wire Bus Data Definition

SDA is used for communication and synchronization between micro controller and AM2305B, and uses single bus data format to transmit 40 bit data at one time. The specific communication sequence is shown in Figure 6, and the communication format specification is shown in Table 4.

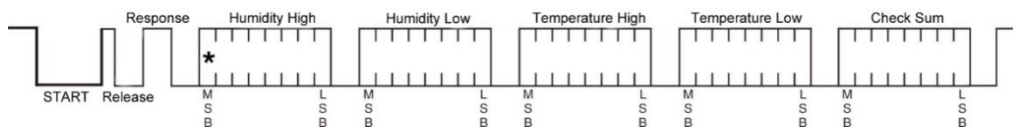

Figure 8. AM2305B Single Bus Communication Protocol

Name	Single bus format definition
START	The microprocessor pulls the data bus (SDA) down for a period of time (at least 800μs), informing the sensor to prepare the data.
Response	The sensor pulls the data bus (SDA) low by 80μs and pills up by 80μs in response to the host's start signal.
Data format	Once receipted from the host start signal, the sensor collects 40 bits of data from the data bus (SDA) at one time, High first out.
Humidity	Humidity resolution is 16Bit, high bit in the former; sensor string out the humidity value is 10 times the actual humidity value.
Temperature	Temperature resolution is 16Bit, high in the former; sensor string out of the temperature value is 10 times the actual temperature; The highest temperature (Bit15) is equal to 1 for negative temperature, the highest temperature bit (Bit15) is equal to 0 for positive temperature; Temperature in addition to the most significant bit (Bit14 ~ Bit0) that the temperature value.
Check Sum	Check Sum = Humidity high bit + Humidity low bit + Temperature high bit + Temperature low bit

Table 4. AM2305B Communication format description

6.2.3 Examples for Single bus data calculation

Example 1 Received 40 bit data is

<u>0000 0010</u>	<u>1001 0010</u>	<u>0000 0001</u>	<u>0000 1101</u>	<u>1010 0010</u>
Humidity High	Humidity Low	Temperature High	Temperature High	Check Sum

Calculation

0000 0010 + 1001 0010 + 0000 0001 + 0000 1101 = 1010 0010 (Check Sum)

So

Received data is correct.

Humidity: 0000 0010 1001 0010 = 0292H (Hexadecimal) = $2 \times 256 + 9 \times 16 + 2 = 658$
 => Humidity = 65.8%RH

Temperature: 0000 0001 0000 1101 = 10DH (Hexadecimal) = $1 \times 256 + 0 \times 16 + 13 = 269$
 => Temperature = 26.9°C

6.2.4 Special Instructions

When the temperature is below 0 °C, the highest bit of the temperature data is 1.

Example : -10.1 °C => 1 000 0000 0110 0101

Temperature: 0000 0000 0110 0101 = 0065H (Hexadecimal) = $6 \times 16 + 5 = 101$
 => Temperature = -10.1°C

Example 2 received 40 bit data is

<u>0000 0010</u>	<u>1001 0010</u>	<u>0000 0001</u>	<u>0000 1101</u>	<u>1011 0010</u>
Humidity high 8bit	Humidity low 8bit	Temperature high 8bit	Temperature high 8bit	Check bit

Calculation:

0000 0010+1001 0010 +0000 0001+0000 1101= 1010 0010 ≠ 1011 0010 (Check error)

The data received this time is not correct. Give up and re-receive data.

6.3 Single Bus Communication Timing

The AM2305B switches from Sleep to High Speed mode when the user host (MCU) sends a start signal (pulls the data bus SDA low by at least 800µs). After the host start signal is completed, the AM2305B sends a response signal and sends 40Bit from the data bus SDA serially. The high bit of the data is sent first. The data sent is: the high bits of humidity, the low bits of humidity, the high bits of temperature, the low bits of temperature, the check digit. The information is collected after sending data ends and the sensor is automatically transferred to the sleep mode until the next A communication comes.

Detailed timing signal characteristics shown in Table 5, single bus communication timing diagram shown in Figure 9.

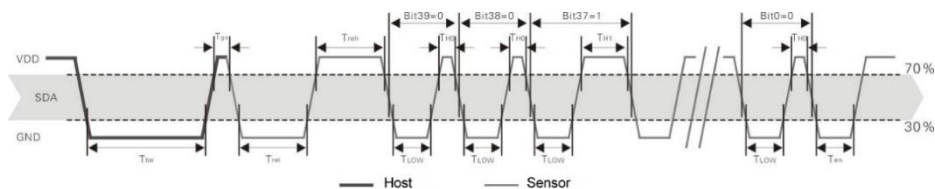

Figure 9. AM2305B Single bus communication timing

Note: The temperature and humidity data the host read from the AM2305B is always the previous measurement. If the two measurement interval is very long, please read twice and use the second measurement value as the value of real-time temperature and humidity values. While reading ,make sure the minimum interval between two measurement is 2 Second.

Symbol	Parameter	Min	Type	Max	Units
T _{be}	Time of the host start signal is pulled low	0.8	1	20	mS
T _{go}	Time of the host releases the bus	10	20	200	μS
T _{rel}	Time to response low level	75	80	85	μS
T _{reh}	Time to response high level	75	80	85	μS
T _{LOW}	Signal“0”“1”low level time	48	50	55	μS
T _{H0}	Signal“0”high level time	22	26	30	μS
T _{H1}	Signal “1”high level time	68	70	75	μS
T _{en}	Time of the sensor releases the bus	45	50	55	μS

Table 5. Single bus signal characteristics

Note: To ensure accurate communication of the sensor, please strictly in accordance with parameters and timing design of Table 5 and Figure 9 when reading the sensors.

6.4 Peripheral Read Step Example

Communication between the host and the sensor can complete by the following three steps.

Step 1

After the AM2305B is powered on (the AM2305B will wait 2S to go beyond the unstable state, during which time the device can not send any instructions), test the environment temperature and humidity data, and record the data, then the sensor automatically goes to sleep. AM2305B SDA data line pulled up by the pull-up resistor and then would keep high, at this state, AM2305B is detect the external signal continuously, and its SDA pin in the input state.

Step 2

The I / O of the microprocessor is set to output and the output is low, and the low hold time can not be less than 800us. The typical value is pulled down 1MS. Then the microprocessor's I / O is set to the input state, the bus is released. Due to pull-up resistor, the microprocessor's I / O that AM2305B SDA data line also will become high. when the host release bus, AM2305B send a response signal, that is, 80us low output as a response signal. After that an 80us high output to inform the peripherals ready to receive data, the signal transmission shown in Figure 10.

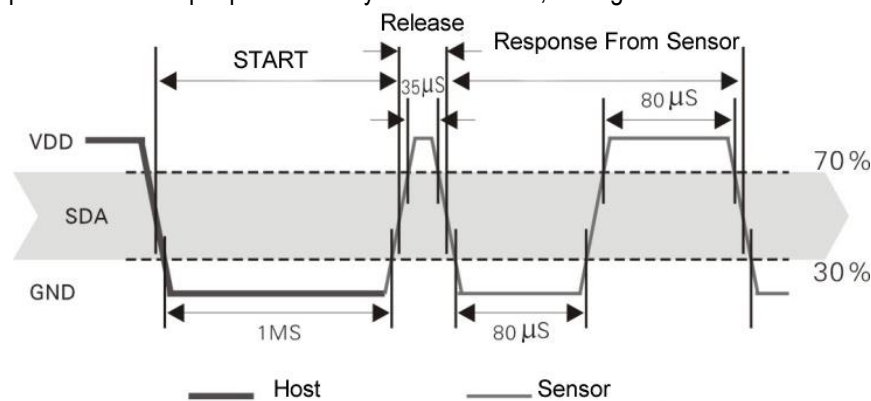

Figure 10. Single Bus Decomposition Timing Diagram

Step 3

AM2305B sends the response, followed by the data bus SDA continue serial output 40-bit data, the microprocessor receive 40-bit data according to the I / O level changes

The format of the bit data "0" is: 50 us low level plus 26-28 us high level;

The format of the bit data "1" is: 50 us low level plus 70 us high level;

The format of the bit data "0", bit data "1" are shown in Figure 11.

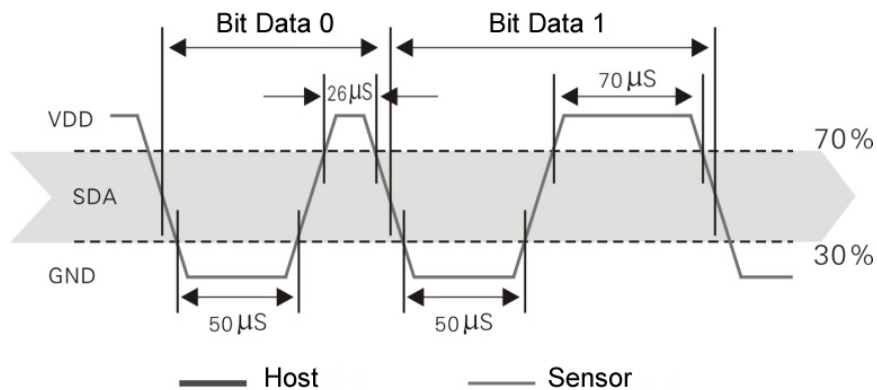

Figure 11. Single Bus Decomposition Sequence Diagram

6.5 Peripheral read flow chart

Flow chart of AM2305B sensor read bus schematic diagram is shown as below:

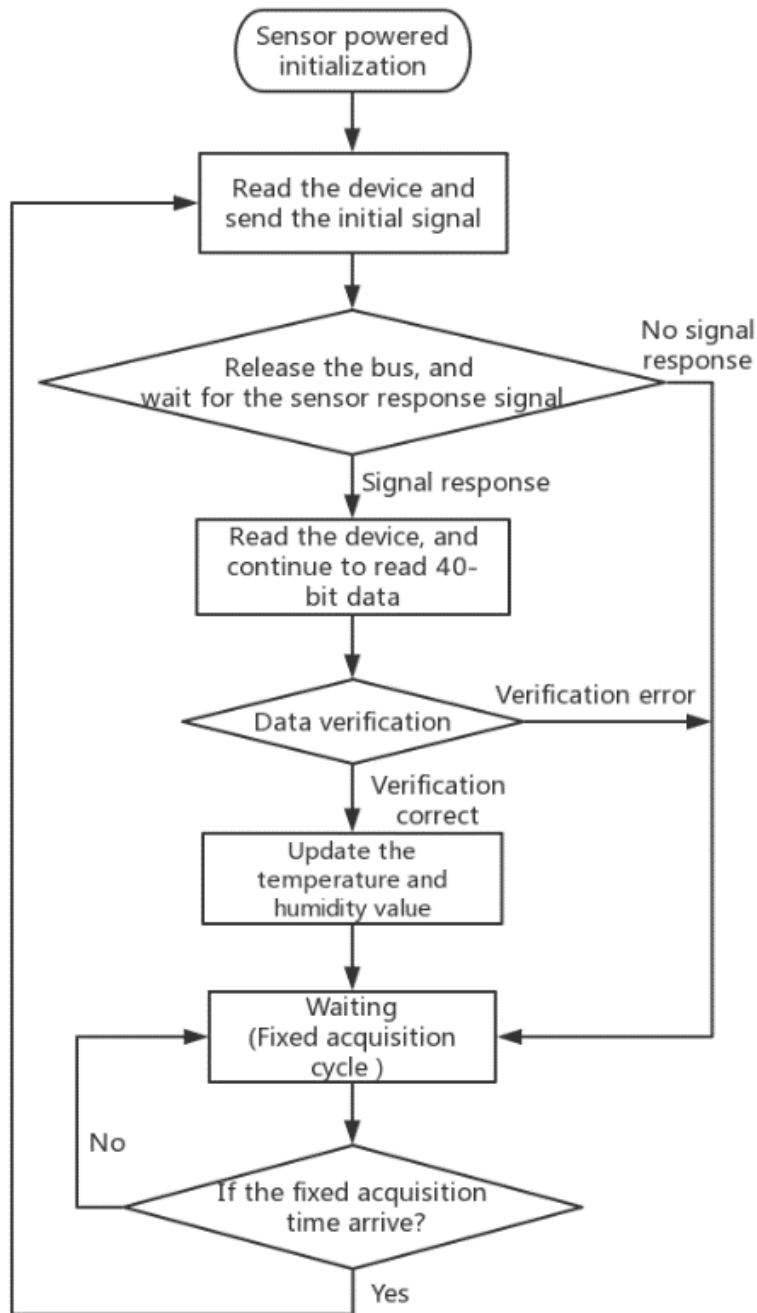

Figure 12. The Single Bus Read Flow Chart

7 Packing Instructions

7.1 Outer Dimensions

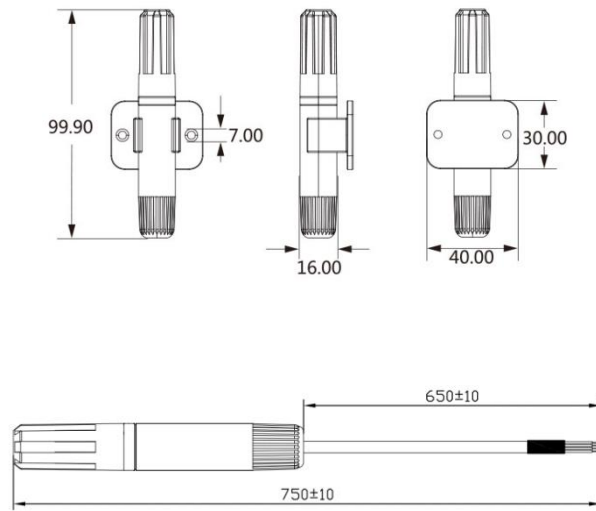

Figure 13. AM2305B sensor encapsulation (unit: mm ; not specified tolerance: ± 0.2 mm)

7.2 Tracking Information

All AM2305B sensors have laser marker on the surface, and are accompanied by markings for parameter descriptions, see Figure 14.

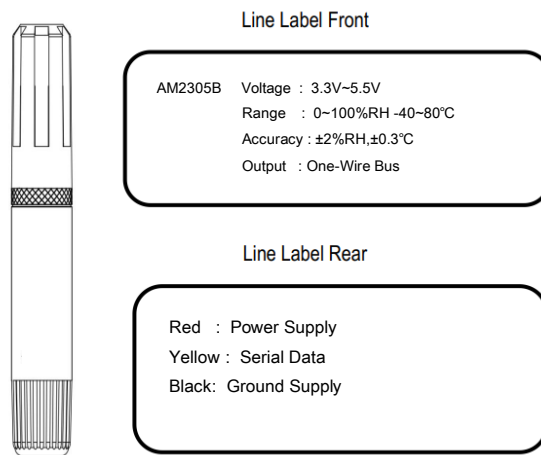

Figure 14. Sensor laser marking

The label on the carton is shown in Figure 15, and provides other tracking information.

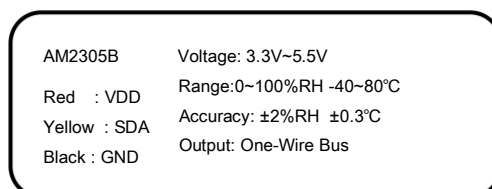

Figure 15. Label on the carton.

7.3 Transport packaging

Each AM2305B is packaged in a cardboard box. Sensor packaging diagram as shown in Figure 16.

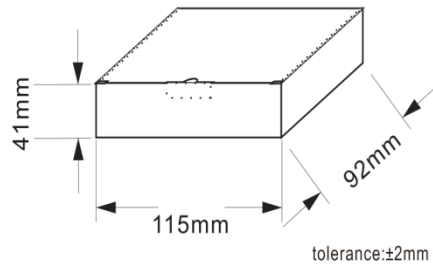

Figure 16. Schematic diagram of packaging

AM2305B Package	Quantity	Gross Weight	Net Weight
Per box	1 pcs	About 80.6g	About 52g

Table 6. Packaging Information

Important Notices

Warning, Personal Injury

Do not apply this product to safety protection devices or emergency stop equipment, and any other applications that may cause personal injury due to the product's failure. Do not use this product unless there is a special purpose or use authorization. Refer to the product data sheet and application guide before installing, handling, using or maintaining the product. Failure to follow this recommendation may result in death and serious personal injury.

If the buyer intends to purchase or use Aosong products without obtaining any application licenses and authorizations, the buyer will bear all the compensation for personal injury and death arising therefrom, and exempt Aosong managers and employees and affiliated subsidiaries from this. Agents, distributors, etc. may incur any claims, including: various costs, compensation fees, attorney fees, etc.

ESD Protection

Due to the inherent design of the component, it is sensitive to static electricity. In order to prevent the damage caused by static electricity or reduce the performance of the product, please take necessary anti-static measures when using this product.

Quality Assurance

The company provides a 12-month (1 year) quality guarantee (calculated from the date of shipment) to direct purchasers of its products, based on the technical specifications in the product data manual published by Aosong. If the product is proved to be defective during the warranty period, the company will provide free repair or replacement. Users need to satisfy the following conditions:

- Notify our company in writing within 14 days after the defect is found.
- The defect of this product will help to find out the deficiency in design, material and technology of our product.
- The product should be sent back to our company at the buyer's expense.
- The product should be within the warranty period.

The company is only responsible for products that are defective when used in applications that meet the technical conditions of the product. The company does not make any guarantees, guarantees or written statements about the application of its products in those special applications. At the same time, the company does not make any promises about the reliability of its products when applied to products or circuits.

This manual may be changed at any time without notice.
Copyright© 2021, **ASAIR**®